

FIREPOWER

ADV. 24

RGB GAMING MOUSE

INSTRUCTION MANUAL

ADXM1224



ADX 

Contents

Safety Warnings.....	3
Product Overview.....	4
Detachable Buttons.....	5
Mouse DPI Settings	5
RGB Light Settings.....	6
Software Installation.....	6
User Interface.....	6
User Interface- Customise.....	7
User Interface- Light.....	7
User Interface - Performance	8
User Interface- Macro.....	8
User Interface - Light Effect	9
System Requirements	9
Hints and Tips.....	10
Specifications.....	10

Safety Warnings

- Read all the instructions carefully before using the unit and keep them for future reference.
- Retain the manual. If you pass the unit onto a third party, make sure to include this manual.
-  Never point the optical sensor towards the face, particularly the eyes, to avoid possible injury.
- While the mouse is functioning, the optical light is visible to the naked eye. Avoid looking directly into the emitter hole while the mouse is active.
- Your product complies with CE rules.
- This product has no serviceable parts. Use of controls or adjustments of procedures other than the Instruction Manual may result in danger.

Thank you for purchasing your new product.

We recommend that you spend some time reading this instruction manual in order that you fully understand all the operational features it offers. You will also find some hints and tips to help you resolve any issues.

Read all the safety instructions carefully before use and keep this instruction manual for future reference.

Product Overview

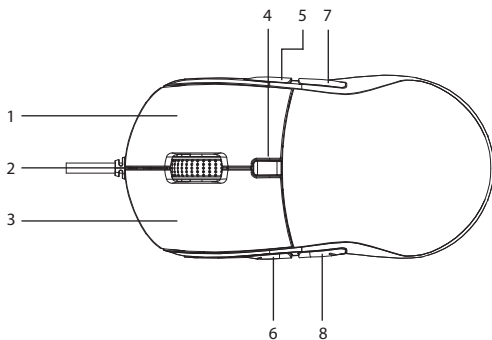

1. Right Button

2. Scroll Wheel

3. Left Button

4. DPI Button

Press repeatedly to select different dpi.

5. Forward (R2) Button

6. Forward (L2) Button

7. Backward (R1) Button

8. Backward (L1) Button

Detachable Buttons

The forward (**L2, R2**) and backward (**L1, R1**) buttons are detachable from the unit. Replace the respective buttons back if they are separated from the unit.

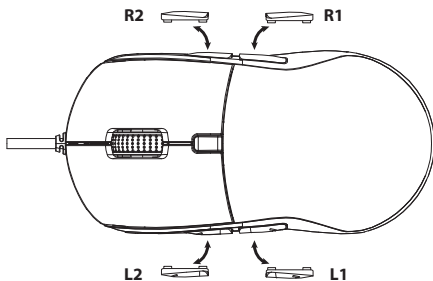

While placing the buttons back to the mouse, make sure that each button (**L1, L2, R1, R2**) is returned to its corresponding slot.

Mouse DPI Settings

Press the **DPI** button on the mouse repeatedly to select desired resolution. Related LED colour will flash for 2 seconds.

Colour	DPI
Red	800
Orange	1600
Yellow	3200
Green	6400
Blue	8000
Purple	12000

RGB Light Settings

Press and hold the **DPI** button and **Backward** button for about 3 seconds to switch the RGB lighting mode between **Stream** / **Breathing** / **Static** / **Pulse** / **Criss Cross** / **React** / **Random** / **Light off**.

Software Installation

1. Plug the unit into the USB port of your computer.
2. Download the latest gaming software from <https://downloads.adxgaming.com> (under **ADX HUB 2**)
3. Run the software (**ADX HUB 2 Setup.exe**) installer.
4. Follow the installation instruction to complete the installation.
5. Choose **ADX HUB 2.exe** from the desktop to start the software.

User Interface

1. Choose **ADX HUB.exe** from the desktop to launch the software.



2. Select "**Mouse**" and then "**ADXM1224**" at the bottom of the connected device list to enter the interface.



User Interface- Customise

1. Select **Customise** to enter the setting page.

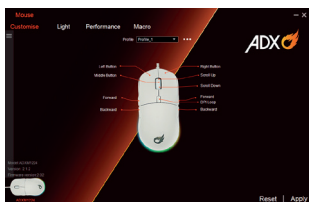

2. Set your preference of the mouse buttons in the **Key Function** menu.
3. You may save your own preference in the **Profile** menu.
4. Select **"Apply"** to implement your settings, or **"Reset"** to reset all settings.

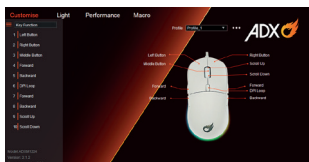

Some **Customise** settings may not be supported. Please check the application program of your computer.

User Interface- Light

1. Select **Light** to enter the **Light Settings** page.
2. Choose your preference among the below:
 - **Mode**
 - **Brightness**
 - **Speed**
3. Select **"Apply"** to implement your settings, or **"Reset"** to reset all settings.

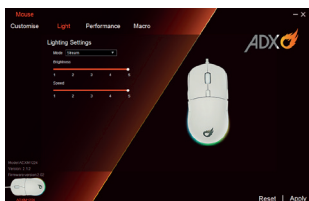

User Interface - Performance

1. Select **Performance** to enter the setting page.
 - Select the **DPI** from **Level 1** to **Level 6**, and then set it from **800** to **12000**.
 - Select the **Response Rate** between **125 Hz**, **250 Hz**, **500 Hz** and **1000 Hz**.
2. Select **Apply** to implement your settings, or **Reset** to reset all settings.

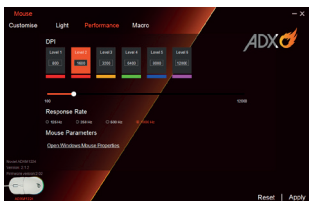

For **Mouse Parameters**, click **Open Windows Mouse Properties** to open the **Mouse Properties** menu of your computer.

User Interface- Macro

1. Select **Macro**, and the "+" to create a **New Macro Command**.
2. Press **Start Recording**.
3. After recording your input command, press **Stop Recording**.
4. You may edit your recorded commands on the right menu.
5. Select **Apply** to implement your settings, or **Reset** to reset all settings.

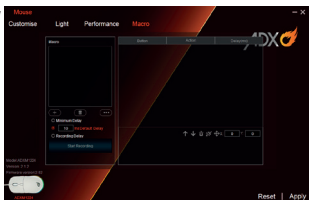

User Interface - Light Effect

If one more ADX gaming device is connected, you may synchronize their light effect.

1. Select **Light Effect**, and the devices you want to apply the light effect.
2. Select your preferred **Lighting Settings (Mode, Brightness and Speed)** and **Color Mode (Customise or Stream)**.
3. Select "**Apply**" to implement your settings.



To reset the setting of a particular device, select a connected device shown in the menu, and then select **Reset**.

System Requirements

Operating Systems: Microsoft® Windows® 8 / 10 / 11

Hardware: 1 available USB port

Hints and Tips

- Make sure the USB plug is fully plugged into a USB port and the computer is on or try to use a different USB port.
- If the mouse is moving erratically, change the working surface which the mouse is operating on.
- If the software is not working properly, uninstall it and then reboot the computer. Re-install the software.
- If the unit is not working properly, re-insert the USB plug into the USB port.

Specifications

Model	ADX1224
Operation Systems	Microsoft® Windows® 8 / 10 / 11
Resolution	800 / 1600 / 3200 / 6400 / 8000 / 12000 dpi
Dimension (L × W × H)	126 × 63.5 × 39 mm
Net Weight	107 g

Features and specifications are subject to change without prior notice.

Currys.co.uk

All the support you need.

Whether it's a tech emergency or
you need plain good advice, we're
always on hand to help.

UK: 0344 561 1234

IRE: 0818 810575

Partmaster
CO.UK

Visit Partmaster.co.uk today for the easiest way to buy electrical spares and accessories.

With over 1 million spares and accessories available we can deliver direct to your door the very next day. Visit **www.partmaster.co.uk** or call **0344 800 3456** (UK customers only). Calls charged at National Rate.



The symbol on the product or its packaging indicates that this product must not be disposed of with your other household waste. Instead, it is your responsibility to dispose of your waste equipment by handing it over to a designated collection point for the recycling of waste electrical and electronic equipment. The separate collection and recycling of your waste equipment at the time of disposal will help conserve natural resources and ensure that it is recycled in a manner that protects human health and the environment. For more information about where you can drop off your waste for recycling, please contact your local authority, or where you purchased your product.

Windows is either trademark or registered trademark of Microsoft Corporation in the United States and/or other countries.

All trademarks are the property of their respective owners and all rights are acknowledged.

Currys Group Limited (co. no. 504877)
1 Portal Way, London, W3 6RS, UK

EU Representative

Currys Ireland Limited (259460)
3rd Floor Office Suite
Omni Park SC, Santry, Dublin 9, Republic of Ireland